



MICROTEX ELECTRONICS, INC.

FRS – Fastreader Submeter Networkable Submeter Module



- For multi-family dwellings or On-Demand Submetering
- Reliable non-volatile meter-reading data collection
- Easy connectivity and reliable operation
- Expandable, Networkable data collection
- Unique Address for each communications module

Single Point, Multi-Meter Data Collection

The Microtex Electronic's **FRS Module** combined with the Microtex **LR2G Gateway**, allows for the collection of multiple submeters into a single collection point. Each **LR2G Gateway** can accept the data from 256 individual dual channel **FRS** submeter modules and report their meter-reading data collectively or individually..with true 2-way communications. Up to 512 Current lines per Gateway Radio. This offers fast, flexible deployment submetering for apartments, marinas, Mobile home parks, and pay as you go systems.

Flexible Configurations

The **FRS can connect directly to an LR2 Radio** and clip-on current sensors for **fast deployment** of submetering without changing the current electric installation. Data collection can be in the main office and submeter modules can count power usage in dollars based on programmable power rates per KWH. This flexibility allows you add billing easily to any existing system, including pay-as-you go systems. Also, the FRS modules are completely non-volatile, and can store data for short periods or over longer durations, and have dual channels for monitoring more than one line per unit to save on deployment costs. The FRS also has convenient KWH Pulse outputs to interface to energy management systems.

Internet Based Data Collection

Each **FRS** has a unique IP Address, so each meter is easily identifiable by ID and addressable node ID. Collection can be made *ON DEMAND* or on a set schedule. Each **FRS** has its own nonvolatile battery-free memory and Switchable COM processor for added intelligence.

Microtex Electronics and its Family of Wireless Communications Products:

Microtex Electronics, Inc. is a group of professionals that design, manufacture, and supply leading-edge technology to meet today and tomorrow's utility data collection needs. Microtex offers a broad range of off-the-shelf and customized solutions for meter data collection, Utility Control, telemetry applications, and much more. Microtex can supply a total system package, solutions for a legacy systems, or anything in between. Call Microtex today at **1-972-479-1011** to see how we can help you streamline and improve your data collection systems.

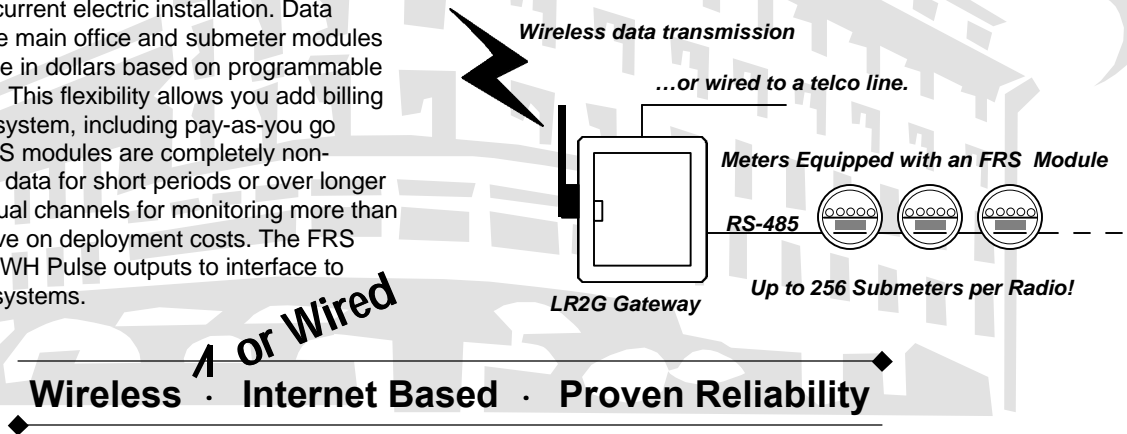

For More Information:

Microtex Electronics, INC.
 3400 North Central Expressway, Ste 256
 Richardson, TX 75080 U.S.A
www.microtexelectronics.com
 TEL: (972) 479-1011
 FAX: (972) 479-1015

Proudly Made in the USA





MICROTEX ELECTRONICS, INC.

FRS – Fastreader Submeter Networkable Submeter Module

Typical Applications:

Example #1: Data Collection: Mobile Home Park

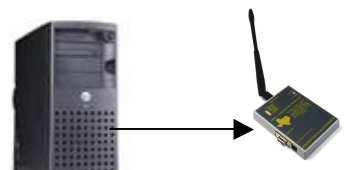

LR2 Radio, Data Collection Point
Or
Mobile Platform Collection



FRS with LR2 Radio, Park "A"

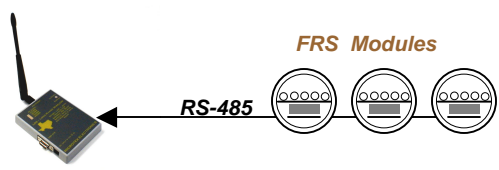

FRS with LR2 Radio, Park "B"

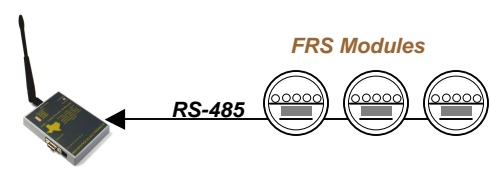

FRS with LR2 Radio, Park "C"

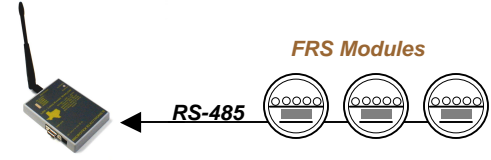

Typical Applications:

Example #2: Pay as you go System

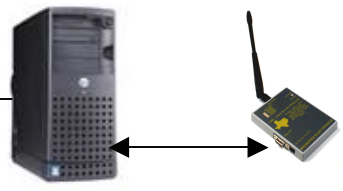

Energy Management System
With LR2 Radio.

Internet to Billing System

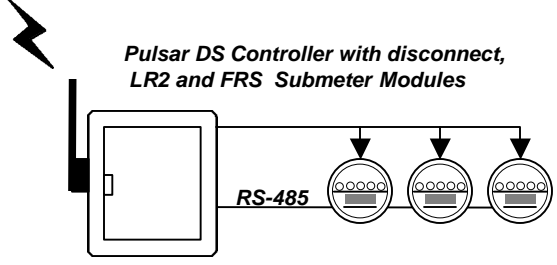
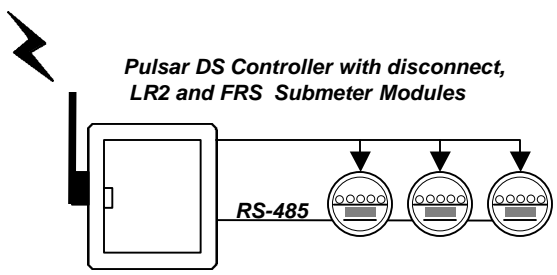

For More Information:

Microtex Electronics, INC.
3400 North Central Expressway, Ste 256
Richardson, TX 75080 U.S.A
www.microtexelectronics.com
TEL: (972) 479-1011
FAX: (972) 479-1015

Proudly Made in the USA

